



# Halo Refrigeration

Edition : January 2016

Retail Prices (Ex GST)

[www.halorefrigeration.com.au](http://www.halorefrigeration.com.au)





## Benefits of Buying from Halo Refrigeration— 1300 673

- |  |                              |
|--|------------------------------|
| ⇒ Australian company, Australian Call Centre | ⇒ Australian product manuals |
| ⇒ Spare parts available                      | ⇒ Electrically compliant     |
| ⇒ MEPS approved                              | ⇒ Foodsafe                   |

### Halo Catalogue Index

- ◆ Halo Fridges & Freezers
- ◆ Medical Fridges 4U
- ◆ Cyberchill
- ◆ Manitowoc Ice Machines
- ◆ Orford Sign Shop



Contact Halo Refrigeration

Phone : 1300 ORFORD (673 673)

Web : [www.halorefrigeration.com.au](http://www.halorefrigeration.com.au)

Sales@halorefrigeration.com.au





## HALO IMPULSE DISPLAY FREEZER

**Halo Glass Door Top Mount Freezer RRP \$2300 + GST**

**Product Code:** Halo G1F-120L

Counter Top Freezer 120L, Top Mount  
External Dims: 605 w x 559.5 d x 915 mm h  
Capacity 120 Litres,

HEATED TEMPERED TRIPLE GLASS

Temp Range: ( -25c ~ -20c )

Direct Cooling

Refrigerant R134a

Climate Tropical

Digital Control and Digital Display

ALARM BEEPS WHEN TEMP IS OVER -20c FOR  
40MINS

Internal LED light,

Light box FLUORESCENT  
LIGHT

Weight 50KG. 2 Shelves



Contact Halo Refrigeration

Phone : 1300 673 673

Web : [www.halorefrigeration.com.au](http://www.halorefrigeration.com.au)

Sales@[halorefrigeration.com.au](mailto:halorefrigeration.com.au)





## HALO FOOD SERVICE RANGE



### **Halo TGF-5SD Freezer RRP \$2430 + GST**

167 litre freezer with LED lights  
Triple Pane Heated Glass doors with heat reflecting film  
Self closing door R404A Refrigerant  
-16 to -24 degrees 3 shelves standard  
External : 635 W x 590 D x 775 H  
weight : 83 kg 10 Amp plug

### **Halo TGM-5SD Refrigerator RRP \$1830 + GST**

167 Litre refrigerator with LED lights  
Temp : 0—10 degrees Levelling Feet  
Double Pane glass doors with Heat Reflecting film  
R134a Refrigerant 3 shelves standards  
External : 635 W x 590 D x 775 H  
Weight 69kg 10 Amp plug



Contact Halo Refrigeration

Phone : 1300 673 673

Web : [www.halorefrigeration.com.au](http://www.halorefrigeration.com.au)

Sales@[halorefrigeration.com.au](mailto:halorefrigeration.com.au)





# halo®



## HALO FOOD SERVICE RANGE

**TOG TGM-7SD**

**Refrigerator**

**215 Litres**

**\$1975 + GST**

Capacity : 215 litres

Temperature Range : 0—10 degrees

Levelling Feet

LED lights

Double pane Glass doors with Heat reflecting film

Dims : 635 w x 590 d x 970 h (mm)

Bottom Mount compressor Unit with R134a Refrigerant

Self-closing and stay open door features

4 shelves as standard

Weight : 77kg



Contact Halo Refrigeration

Phone : 1300 673 673

Web : [www.halorefrigeration.com.au](http://www.halorefrigeration.com.au)

Sales@[halorefrigeration.com.au](mailto:halorefrigeration.com.au)





## HALO FOOD SERVICE RANGE

**Halo TGF-10SD    Single Door Freezer    263lt    RRP \$3825 + GST**

LED lights

Triple Pane Heated Glass doors with heat Reflecting Film

Self closing door. Freezer has levelling feet.

R404A refrigerant

Rated Temp -16 to -24 degrees

4 shelves as standard

655W x 590 D x 1380 H

Weight 89 kg

Available in black or white

10amp Insulated Australian Plug



**Halo TGM-10SD**

**263 Litres**

**\$2450 + GST**

Modern Design

LED Lighting-Brighter and longer lasting LED lights provide attractive

enhanced illumination compared to fluorescent lights, Energy saving

Efficient Refrigeration System

Double Pane Glass Doors with Heat Reflecting Film

High-Density Polyurethane Insulation

Self-closing and stay open door features

Bottom Mount Compressor Units with R134a Refrigerant

4 Shelves as standard

External Dims: W655 x D590 x H1380mm

Internal Dims: W545 x D475 x H1020mm

Weight 89kg. External Finish Colour Black Or White

10Amp Insulated Australian Plug



**Contact Halo Refrigeration**

**Phone : 1300 673 673**

**Web : [www.halorefrigeration.com.au](http://www.halorefrigeration.com.au)**

**Sales@halorefrigeration.com.au**





# halo®



## HALO FOOD SERVICE RANGE

**HALO TGM-12SD Refrigerator RRP \$2495 + GST**

320 Litre capacity    Temperature : 0—10 degrees

4 Shelves    Weight : 99kg

Refrigerant : R134a

Dimensions : 655 w x 590 D x 1600 H

Movement : Levelling Feet

Shadow Free Advertising Panel

Modern sleek design



Contact Halo Refrigeration

Phone : 1300 673 673

Web : [www.halorefrigeration.com.au](http://www.halorefrigeration.com.au)

Sales@[halorefrigeration.com.au](mailto:halorefrigeration.com.au)





**Halo TGF-15SD Freezer RRP \$4695 + GST**

450 litre freezer with Digital Temperature Control

LED lights

-16 to -24 degrees

External : 670W x 630D x 1920H

Internal : 560W x 515 D x 1560H

5 shelves standard weight : 142kg 10 Amp plug

Available in Black or White



**Halo TGM-15SD Refrigerator RRP \$3565 + GST**

450 litre refrigerator

LED lights

External : 670W x 630D x 1920H

Internal : 560W x 515D x 1560H

5 shelves standard

weight: 109kg 10 Amp plug

Available in black or white



Contact Halo Refrigeration

Phone : 1300 673 673

Web : [www.halorefrigeration.com.au](http://www.halorefrigeration.com.au)

Sales@[halorefrigeration.com.au](mailto:halorefrigeration.com.au)







**Halo TGM-23SD**

**Refrigerator**

**RRP \$3885 + GST**

597 litre refrigerator with LED lights

Shadow free advertising panel

Double pane glass doors with heat reflective film

Bottom Mount with R134A

External : 685W x 770D x 1955H

Internal : 585W x 655 D x 1535H

5 shelves standard weight : 150kg 10 Amp plug

Available in Black or White



**Halo TGF-23SD**

**Freezer**

**RRP \$5410 + GST**

597litre Freezer with LED lights

Shadow Free Advertising Panel

No electrical Frame Heater is needed due to compressor produced heat up the door

Triple Pane heated Glass doors with heat reflective film

Bottom mount compressor units with R404A

Rated Temp : -16 to -24c

External : 685W x 770D x 1955H

Internal : 585W x 655D x 1535H

5 shelves standard weight: 175kg 10 Amp plug

Available in black or white



**Contact Halo Refrigeration**

**Phone : 1300 673 673**

**Web : [www.halorefrigeration.com.au](http://www.halorefrigeration.com.au)**

**Sales@halorefrigeration.com.au**





**Halo TGF-35SD Slimline Freezer RRP \$7455 + GST**

**1048 Lt Freezer**

Digital Temperature control system

LED Lights

Shadow free advertising panel

Temperature -16 to -24 degrees

External : 1004W x 809D x 19556H

Internal : 904W x 699D x 1535H

Weight : 231kg

Available in Black or white

15 Amp Insulated Australian Plug



**Halo TGM-35SD Slimline Refrigerator RRP \$4600 + GST**

1047 litre refrigerator

LED lights

External : 1004 W x 809 D x 1956 H

Internal : 904 W x 699 D x 1535 H

10 shelves standard weight 197 kg 10 Amp plug

Available in black or white



Contact Halo Refrigeration

Phone : 1300 673 673

Web : [www.halorefrigeration.com.au](http://www.halorefrigeration.com.au)

Sales@[halorefrigeration.com.au](mailto:halorefrigeration.com.au)





**Halo TGF-47SD Freezer RRP \$8425 + GST**

1308 litre freezer with Digital Temperature Control

LED lights

-16 to -24 degrees

External : 1299 W x 809D x 1956 H

Internal : 1199 W x 699 D x 1535H

10 shelves standard weight : 265 kg 15 Amp plug

Available in Black or White



**Halo TGM-47SD Refrigerator RRP \$4955 + GST**

1308 litre refrigerator

LED lights

External : 1299 W x 809 D x 1956 H

Internal : 1199 W x 699 D x 1535 H

10 shelves standard weight: 230kg

10 Amp plug

Available in black or white



Contact Halo Refrigeration

Phone : 1300 673 673

Web : [www.halorefrigeration.com.au](http://www.halorefrigeration.com.au)

Sales@[halorefrigeration.com.au](mailto:halorefrigeration.com.au)





## Halo TGF-72SD

## Freezer 2019LT FREEZER

RRP \$11825 + GST

Digital Temperature control

LED lights

-16 to -24 degrees

External : 1981 W x 809D x 1956 H

15 shelves standard

weight : 356 kg

15 Amp plug

Available in Black or White



## Halo TGM-72SD

## 2019 litre REFRIGERATOR

RRP \$7775 + GST

External : 1981 W x 809 D x 1956 H

Internal : 1891 W x 709 D x 1556 H

15 shelves standard

weight: 310kg

15 Amp plug

LED lights

Available in black or white



Contact Halo Refrigeration

Phone : 1300 673 673

Web : [www.halorefrigeration.com.au](http://www.halorefrigeration.com.au)

Sales@halorefrigeration.com.au





## Halo TOG G1R-600 Refrigerator

**RRP \$2200 + GST**

600 litre refrigerator with LED lights and light box

Dims : 770w x 730d x 2031h mm

Temp Range 0—5 degrees

4 adjustable shelves weight : 102 kg



## Halo TOG G1F-650 Freezer

**RRP \$4860 + GST**

650 litre freezer with Digital Temperature Control

LED lights

-16 to -24 degrees

External : 685 W x 760D x 1984

4 shelves standard weight : 171 kg 10 Amp plug



## Halo TOG G2F-1250 Freezer

**RRP \$7950 + GST**

1250 litre refrigerator

LED lights

-16 to -24 degrees

External : 1382 W x 760 D x 1984 H

10 shelves standard weight: 266kg 15 Amp plug



## Contact Halo Refrigeration

Phone : 1300 673 673

Web : [www.halorefrigeration.com.au](http://www.halorefrigeration.com.au)

Sales@halorefrigeration.com.au





### **Halo TOG KDU45-2 Dual Temp Fridge / Freezer RRP \$7135 + GST**

Stainless Steel top Mount Dual Temperature

Fridge with Freezer Two compressor system

Capacity in litres - Freezer 464 litres / Fridge 645 litres = 1109 litres

Blue—Freezer, Green—Fridge

Temperature—Fridge 2c to 6c Freezer— -21c to -12c

6 shelves (3 per door)

Fridge—R-134A 4.4amps power—w673, 15amp insulated Australian plug

Dimensions : 1260W x 800D x 1935H (including castors)

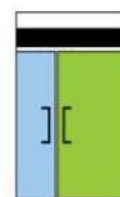

### **Halo TOG KDU45-3 Dual Temp Fridge / Freezer RRP \$7445 + GST**

Stainless Steel top Mount Dual Temperature

Fridge with Freezer Two compressor system

Capacity in litres - Freezer 464 litres / Fridge 642 litres = 1106 litres

Blue—Freezer, Green—Fridge

Temperature—Fridge 2c to 6c Freezer— -21c to -12c

6 shelves (3 per door)

Fridge—R-134A 4.4amps power—w673, 15amp insulated Australian plug

Dimensions : 1260W x 800D x 1935H (including castors)

Weight : 150kg

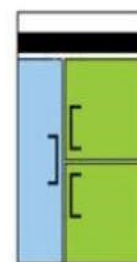

Contact Halo Refrigeration

Phone : 1300 673 673

Web : [www.halorefrigeration.com.au](http://www.halorefrigeration.com.au)

Sales@[halorefrigeration.com.au](mailto:halorefrigeration.com.au)





**Halo TOG KDU65-3 Dual Temp Fridge / Freezer RRP \$8815 + GST**

Stainless Steel top Mount Dual Temperature Two compressor system

Capacity in litres - Freezer 555 litres / Fridge 1275 litres = 1830 litres

Blue—Freezer, Green—Fridge

Temperature—Fridge 2c to 6c Freezer— -21c to -12c

9 shelves (3 per door)

Fridge—R-134A 4.4amps power—w673, 15amp insulated Australian plug

Dimensions : 1900W x 800D x 1935H (including castors)

Weight : 175kg

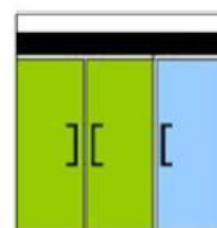

**Halo TOG KDU65-6 Dual Temp Fridge / Freezer RRP \$10130 + GST**

Stainless Steel top Mount Dual Temperature 6 half door capacity

Fridge with Freezer Two compressor system

Capacity in litres - Freezer 555 litres / Fridge 1175 litres = 1730 litres

Blue—Freezer, Green—Fridge

Temperature—Fridge 2c to 6c Freezer— -21c to -12c

9 shelves (3 per door)

Fridge—R-134A 4.4amps power—w673, 15amp insulated Australian plug

Dimensions : 1900W x 800D x 1935H (including castors)

Weight : 177kg

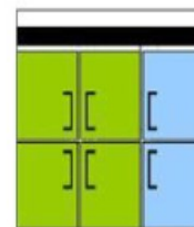

Contact Halo Refrigeration

Phone : 1300 673 673

Web : [www.halorefrigeration.com.au](http://www.halorefrigeration.com.au)

Sales@[halorefrigeration.com.au](mailto:halorefrigeration.com.au)





# halo®



HALO FOOD SERVICE RANGE— The Halo K Series



**KR25-1 Fridge**

**KF25-1 Freezer**



**KR45-1 Fridge**

**KF45-1 Freezer**



**KR65-1 Fridge**

**KF65-1 Freezer**



Contact Halo Refrigeration

Phone : 1300 673 673

Web : [www.halorefrigeration.com.au](http://www.halorefrigeration.com.au)

Sales@halorefrigeration.com.au







# halo®



## HALO FOOD SERVICE RANGE— The Halo K Series



### The K Series Features

- Designed to 40 Degrees ambient operating temperature
- Requires one standard power point : - 240V 50Hz 10 amp
- Digital Temperature Display
- 3 height adjustable shelves per door. Individual shelves behind each door maximize storage configurations
- Stainless steel construction for superior corrosion resistance
- Stainless steel internal floor with coved corners allows for easy cleaning and sanitizing
- Large castors for ease of cabinet movement
- Solid lockable doors. Designed with recessed handle and self closing hinging with 90 degree dwell feature
- LED interior lighting
- One piece door gaskets, removable without tools for easy cleaning
- Automatic energy efficient hot gas condensate disposal. No drainage required
- Internal Pressure release valve

Contact Halo Refrigeration

Phone : 1300 673 673

Web : [www.halorefrigeration.com.au](http://www.halorefrigeration.com.au)

Sales@[halorefrigeration.com.au](mailto:halorefrigeration.com.au)





# halo®



## HALO FOOD SERVICE RANGE— The Halo K Series



Model	Temp	Doors	Net Volume	Shelves	Dimensions	Power 220v 50Hz	Shipping Weight
Halo KR25-1	Refrigerator 1~ 8 degrees	1	574	3	640w x 850d x 1926h	314w	115
Halo KF25-1	Freezer -21 ~ -12 degrees	1	574	3	640w x 850d x 1926h	496w	120
Halo KR45-2	Refrigerator 1 ~ 8 degrees	2	1215	6	1260w x 850d x 1926h	366w	190
Halo KF45-2	Freezer -21~-12 degrees	2	1215	6	1260w x 850d x 1926h	774w	200
Halo KR65-3	Refrigerator 1—8 degrees	3	1876	9	1900w x 850d x 1926h	732w	280
Halo KF65-3	Freezer -21 ~ 12 degrees	3	1876	9	1900w x 850d x 1926h	1346w	280

Note : the depth includes 50mm for the rear condensate tray

### Contact Halo Refrigeration

Phone : 1300 673 673

Web : [www.halorefrigeration.com.au](http://www.halorefrigeration.com.au)

Sales@halorefrigeration.com.au





## HALO FOOD SERVICE RANGE— The Halo K Series



### SPECIFICATIONS

- Electronic Controller—Provides precise and constant temperature.
- High-tech Monitor—The monitor digitally displays the present temperature. You can easily change the temperature by adjusting the thermostat
- Lighting : LED interior lights activated by rocker switches mounted above each door.
- Hot Gas Condensate System : The condensate system surfaces have been specially treated to resist corrosion. This not only increases efficiency without the risk of refrigerant leakage from corrosion, but also prevents the overflow of condensate water.
- Door Pressure Release Device : Pressure relief doors are designed to eliminate vacuum pressure and allow easy, instant door opening
- Insulation : 50mm high pressure injected polyurethane foam
- Gasket : PVC welded one piece magnetic gasket. Removable without tools for easy cleaning
- Hinging : Self closing with 90 degrees dwell open
- Shelves : 3 adjustable, PVC coated, steel shelves per door
- Castors : 100mm heavy duty castors, front locking
- Electrical : Cabinets are ready for connection to a 220volt 50hz 10amp GPO. It is recommended that a dedicated GPO is used.

Contact Halo Refrigeration

Phone : 1300 673 673

Web : [www.halorefrigeration.com.au](http://www.halorefrigeration.com.au)

Sales@[halorefrigeration.com.au](mailto:halorefrigeration.com.au)





## HALO FOOD SERVICE RANGE— The Halo K Series



ELEVATIONS. (not to scale)

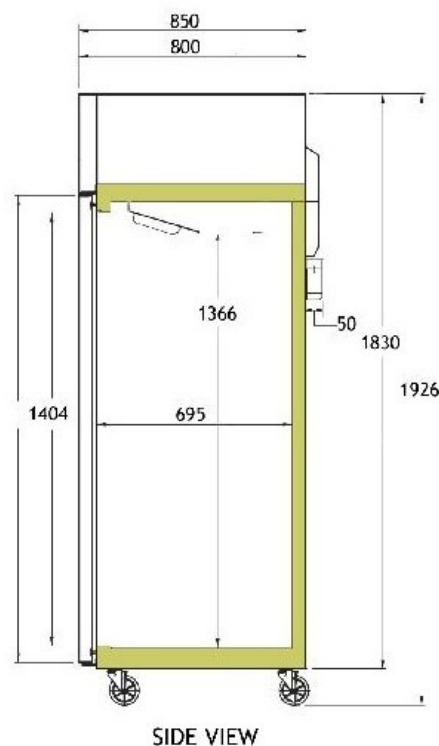
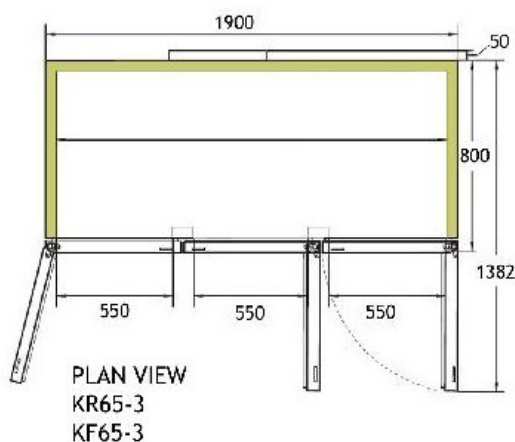
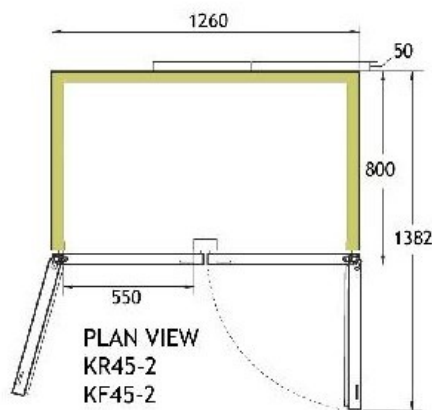
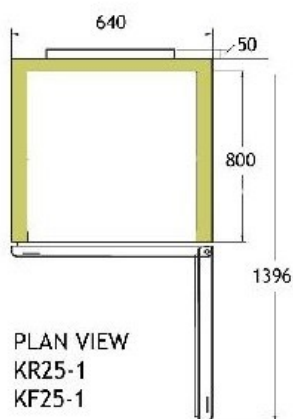

Contact Halo Refrigeration

Phone : 1300 673 673

Web : [www.halorefrigeration.com.au](http://www.halorefrigeration.com.au)

Sales@halorefrigeration.com.au





## HALO FOOD SERVICE RANGE— The Halo K Series

### **Halo KR25-1 574 litre Refrigerator RRP \$3595 + GST**

Stainless Steel Top Mount Single door refrigerator, 574 litre  
Ventilated Cooling Temp Range : 1c to 8c  
Digital Controller and Display 3 Adjustable shelves  
Refrigerant R-134a Amps 3.5 Power - W366  
10 Amp  
Dimensions: 640 W x 850 D x 1926 H (Including Castors )  
Weight—80kg



### **Halo KR45 -2R Refrigerator 1215 litre RRP \$4905 + GST**

Stainless Steel Top Mount 2 door refrigerator, Volume 1215 litres  
Temp Range : 1 degree to 8 degrees  
3 Adjustable shelves per Door  
Digital controller and Display  
Refrigerant R-134a 10 Amp Australian Plug  
Dimensions W 1260 x D 850 x H 1926 mm Including castors  
Weight— 142 kg

### **Halo KR65-3F 3 Door Refrigerator 1876 litre RRP \$7470 + GST**

3 Door Top Mount Refrigerator Volume : 1876 litres  
Stainless Exterior & Interior  
3 Adjustable Shelves per Door Refrigerant R-134a  
Fan Cooling Type Digital Control and Display  
Temp Range 1 degree to 8 degrees  
Weight 167KG  
W 1900 x D 800 x H 1926 mm Including the castors  
D830mm inc Evaporator Tray H2106 Inc castors  
15 Amp Australian Plug



Contact Halo Refrigeration

Phone : 1300 673 673

Web : [www.halorefrigeration.com.au](http://www.halorefrigeration.com.au)

Sales@[halorefrigeration.com.au](mailto:halorefrigeration.com.au)





## HALO FOOD SERVICE RANGE— The Halo K Series

### Halo KF25-1F Freezer 574 litre RRP \$4050 + GST

Stainless Steel Top Mount Single door freezer, 574 litre  
 Ventilated Cooling Temp Range -12c to -25c  
 Digital Controller and Display 3 Adjustable shelves  
 Refrigerant R-404a Amps 3.5 Power - W496 10 Amp  
 Dimensions: 640 W x 850 D x 1926 H (Including Castors )  
 Weight—80kg

Energy consumed 16.45 kWh / 24 hrs

Rated at 40 degree ambient



### Halo KF45 -2F Freezer 1215 litre RRP \$6295 + GST

Stainless Steel Top Mount 2 door freezer, Volume 1215 litres  
 Temp Range -12c to -21c  
 3 Adjustable shelves per Door  
 Digital controller and Display  
 Refrigerant R-404a Amps 5.3, Power W774 10 Amp Australian Plug  
 Dimensions W 1260 x D 850 x H 1926 mm Including castors  
 Weight— 142 kg



### Halo KF65-3F 3 Door Freezer 1876 litre RRP \$9090 + GST

3 Door Top Mount Freezer Volume : 1876 litres  
 Stainless Exterior & Interior  
 3 Adjustable Shelves per Door  
 Refrigerant R-404a  
 Fan Cooling Type Digital Control and Display  
 Temp Range -12 degrees to -21c  
 Power 1346 w Amps 8.5  
 Weight 167KG 10AMP plug  
 W 1900 x D 800 x H 1926 mm Including the castors



Contact Halo Refrigeration

Phone : 1300 673 673

Web : [www.halorefrigeration.com.au](http://www.halorefrigeration.com.au)

Sales@halorefrigeration.com.au





## HALO FOOD SERVICE RANGE— The Halo K Series

**Halo KR25-1G Refrigerator 574 litre RRP \$3435 + GST**

Stainless Steel 1 door top mount refrigerator with lockable glass display door  
Temperature range 0c—8c  
Refrigerant R-134a  
Dimensions : 640 w x 850 d x 1926 h mm (including castors)  
Weight : 87 kg  
240v / 50hz / 1  
Energy consumption 5.51 kWh / 24 hr

6 shelves  
3.5 Amps, Power 366w  
Lockable castors  
10 Amp Australian plug



**Halo KR45 -2G Refrigerator 1215 litre RRP \$4950 + GST**

Stainless Steel 2 door top mount refrigerator with 1215 litre capacity  
Glass doors with key lock  
Door open warning  
Temperature range : 0 c to 8 c  
3 shelves per door plus base  
Dimensions : 1260w x 850d 1926h mm (incl castors)  
Weight 152kg  
Energy consumption 9.65 kWh / 24 hr

Soft touch controller  
Digital temperature display  
Refrigerant : R134a

**Halo KR45-4G 4 Half Door Fridge 1210 litre RRP \$5450 + GST**

Four half glass door display fridge with 1210 litre capacity  
Stainless steel interior and exterior  
Glass doors with key lock  
Door open warning  
3 shelves per door plus base  
internal lighting  
Temperature range : 0c to 8c  
Dimensions : 1260w x 850d x 1926h (incl castors)  
Weight : 152kg

soft touch controller  
Digital temperature display,

Energy consumption 9.65 kWh / 24 hr



## Contact Halo Refrigeration

Phone : 1300 673 673

Web : [www.halorefrigeration.com.au](http://www.halorefrigeration.com.au)

Sales@[halorefrigeration.com.au](mailto:halorefrigeration.com.au)





## HALO FOOD SERVICE RANGE— The Halo K Series

**Halo KR65-3G Refrigerator      1876 litre      RRP \$7,500 + GST**

Stainless Steel 3 door top mount refrigerator with lockable glass display door  
Temperature range 0c—8c      3 shelves per door  
Refrigerant R-134a  
Glass doors with key  
Soft touch controller  
6 Amps, Power 732w  
Dimensions : 1900 w x 850 d x 1926 h mm (including castors)  
Weight : 177kg      Lockable castors  
240v / 50hz / 1  
10 Amp Australian plug

Energy consumption 12.89 kWh/24 hrs



**Halo KR65-6G 6 Half Door Fridge 1868 litre      RRP \$7985 + GST**

Six half glass door display fridge with 1868 litre capacity  
Stainless steel interior and exterior  
Glass doors with key lock      soft touch controller  
Door open warning      Digital temperature display,  
3 shelves per door plus base  
internal lighting  
Temperature range : 0c to 8c  
Dimensions : 1900 w x 850d x 1926h (incl lockable castors)  
Weight : 177g  
Running Current 6 Amps, input Power 732w

Energy consumption 12.89 kWh / 24 hrs



Contact Halo Refrigeration

Phone : 1300 673 673

Web : [www.halorefrigeration.com.au](http://www.halorefrigeration.com.au)

Sales@[halorefrigeration.com.au](mailto:halorefrigeration.com.au)







## HALO FOOD SERVICE RANGE— The Halo K Series

**Halo KF25-1G Freezer 574 litre RRP \$4800 + GST**

Stainless Steel 1 door top mount freezer with glass door  
 574 litre capacity  
 Temperature range -21c to -8c 3 shelves  
 Refrigerant R-404a Digital controller 4.5 Amps,  
 Power 660w  
 Dimensions : 640 w x 850 d x 1926 h (including lockable castors)  
 Weight : 95 kg 10 Amp Australian plug

Energy consumption : 16.45 kWh / 24 hrs



**Halo KF25 -2G Freezer 572 litre RRP \$4950 + GST**

Stainless Steel 2 door top mount freezer with two glass half doors  
 572 litre capacity  
 Door open warning Digital temperature display  
 Temperature range : -21c to -12 c Refrigerant : R404a  
 3 adjustable shelves per door plus base  
 Dimensions : 640 w x 850 d 1926 h mm (incl castors)  
 Weight : 95 kg

Energy consumption : 16 kWh / 24 hrs

Contact Halo Refrigeration

Phone : 1300 673 673

Web : [www.halorefrigeration.com.au](http://www.halorefrigeration.com.au)

Sales@halorefrigeration.com.au





## HALO FOOD SERVICE RANGE— The Halo K Series



**Halo KF45 -2G Freezer 1215 litre**

**RRP \$7900 + GST**

Stainless Steel 2 door top mount freezer with glass doors

1215 litre capacity

Door open warning

Temperature range : -21c to -12 c

3 adjustable shelves per door plus base

Digital temperature display

Refrigerant : R404a

Dimensions : 1260 w x 850 d 1926 h mm (incl castors)

Weight 170 kg

Energy consumption : 28.1 kWh / 24 hrs

**Halo KF45-4G 4 Half Door Freezer 1210 litre RRP \$8050 + GST**

Four half glass door display freezer with 1210 litre capacity

Stainless steel interior and exterior

Glass doors with key lock

Door open warning

3 shelves per door plus base

internal lighting

Temperature range : -21c to -12c

soft touch controller

Digital temperature display,

10 amp plug

Dimensions : 1260 w x 850 d x 1926 h (incl castors)

Weight : 170kg

Energy consumption : 28.1 kWh / 24 hrs



Contact Halo Refrigeration

Phone : 1300 673 673

Web : [www.halorefrigeration.com.au](http://www.halorefrigeration.com.au)

Sales@[halorefrigeration.com.au](mailto:halorefrigeration.com.au)





# halo®



## HALO FOOD SERVICE RANGE



**Halo CTSR-35SD 2 Door Upright Refrigerator RRP \$6200 + GST**

2 door with Door Open Warning

Capacity : 917 Litre

Ventilated Cooling

Temp Range : 0c to +8c

Soft touch control. Rapid Chill Setting. 3 adjustable shelves per door

Refrigerant R-134A Amps 3.3 Power-w366 10 Amp

Dims : 1003 w x 770 d x 2113 h (mm including castors)

Weight—180kg

**Halo AM-50R-PT Pass Through Refrigerator**

**RRP \$9500 + GST**

Pass Through Food Service Refrigerator

Dims : 1314 w x 930 d x 2132 h

Capacity : 1470 litres

Doors : 4 doors (2 front and 2 rear)

Refrigerant : R134a

Digital control system with Self—diagnostic Technology

Amps : 5

Weight : 250kg



Contact Halo Refrigeration

Phone : 1300 ORFORD (673 673)

Web : [www.halorefrigeration.com.au](http://www.halorefrigeration.com.au)

Sales@orford.com.au





# halo®



## HALO FOOD SERVICE UNDERBENCH

### Halo KUF9-1

### FREEZER

RRP \$ 3375 + GST

Undercounter freezer—198 litres

All stainless steel 304

Left hand side Embraco Compressor,

EBM Fan Temperature Range : -21c to -12 degrees

1 shelf, weight 72 kg

Refrigerant R404a

LED Digital Display and Soft Touch Controller

Dimensions : 900 w x 700 d x 850 h (mm)

On castors.

10 Amp plug



### Halo KUR9-1

### REFRIGERATOR

RRP \$ 3115 + GST

Undercounter Refrigerator —198 litres

All stainless steel 304

Left hand side Embraco Compressor,

EBM Fan Temperature Range : 1c to 6c degrees

1 shelf, weight 72 kg

Refrigerant 134A

LED Digital Display and Soft

Touch Controller

Dimensions : 900 w x 700 d x 850 h (mm)

On castors.

10

Amp plug

## Contact Halo Refrigeration

Phone : 1300 ORFORD (673 673)

Web : [www.halorefrigeration.com.au](http://www.halorefrigeration.com.au)

[Sales@orford.com.au](mailto:Sales@orford.com.au)





# halo®



## HALO FOOD SERVICE K Series UNDERBENCH RANGE



### **Halo KUR12-2 Undercounter Fridge RRP \$3415 + GST**

Embraco compressor, EBM fan Capacity 311 Litre

Temperature Range 0c to 8c, 70mm insulation

Refrigerant Gas : R134a

2 shelves, 3 Amps, input power 314w, Weight 84kg

LED Digital Display and soft touch controller

Dims : 1200 w x 700 d x 850 h (mm) On castors

### **Halo KUF12-2 Undercounter Freezer RRP \$3710 + GST**

Embraco compressor, EBM fan Capacity 311 Litre

Temperature Range : -21c to -12 degrees, 70mm insulation

Refrigerant Gas : R404a

2 shelves, 3 Amps, input power 366w, Weight 84kg

LED Digital Display and soft touch controller

Dims : 1200 w x 700 d x 850 h (mm) On castors



**Drawer options available**

**Contact Halo Refrigeration**

**Phone : 1300 ORFORD (673 673)**

**Web : [www.halorefrigeration.com.au](http://www.halorefrigeration.com.au)**

**Sales@orford.com.au**





# halo®



## HALO FOOD SERVICE K Series UNDERBENCH RANGE

### **Halo KUR15-2 Undercounter Fridge RRP \$3900 + GST**



Embraco compressor, EBM fan Capacity 425 Litre

Temperature Range 0c to 8c, 70mm insulation

Refrigerant Gas : R134a

2 shelves, 3 Amps, input power 314w, Weight 93kg

LED Digital Display and soft touch controller

Dims : 1500 w x 700 d x 850 h (mm) On castors

### **Halo KUF15-2 Undercounter Freezer RRP \$4100 + GST**

Embraco compressor, EBM fan Capacity 425 Litre

Temperature Range : -21c to -12 degrees, 70mm insulation

Refrigerant Gas : R404a

2 shelves, 3 Amps, input power 366w, Weight 84kg

LED Digital Display and soft touch controller

Dims : 1500 w x 700 d x 850 h (mm) On castors



Contact Halo Refrigeration

Phone : 1300 ORFORD (673 673)

Web : [www.halorefrigeration.com.au](http://www.halorefrigeration.com.au)

Sales@orford.com.au





# halo®



## HALO FOOD SERVICE K Series UNDERBENCH RANGE

### **Halo KUR18-3 Undercounter Fridge RRP \$4200 + GST**



Embraco compressor, EBM fan Capacity 538 Litre

Temperature Range 0c to 8c, 70mm insulation

Refrigerant Gas : R134a

3 shelves, 4.4 Amps, input power 366w, Weight 109kg

LED Digital Display and soft touch controller

Dims : 1800 w x 700 d x 850 h (mm)

On castors

### **Halo KUF18-3 Undercounter Freezer RRP \$4800 + GST**

Embraco compressor, EBM fan Capacity 538 Litre

Temperature Range : -21c to -12 degrees, 70mm insulation

Refrigerant Gas : R404a

3 shelves, 4.4 Amps, input power 613w, Weight 109kg

LED Digital Display and soft touch controller

Dims : 1800 w x 700 d x 850 h (mm)

On castors



Contact Halo Refrigeration

Phone : 1300 ORFORD (673 673)

Web : [www.halorefrigeration.com.au](http://www.halorefrigeration.com.au)

Sales@orford.com.au





## HALO FOOD SERVICE K Series **DUAL TEMP UNDERBENCH RANGE**

### **Halo KURF12-2 Fridge / Freezer Combo RRP \$4500 + GST**



Dual temperature 2 Door Undercounter

Freezer Capacity 134 Litre    Temp Range -21c to -12c,    Gas : 404a

Fridge capacity 136 Litre    Temp Range 1c to 5c    Gas : 134a

2 doors, 1 shelf per door, 3 Amps, input power 316 w, Weight 87kg

Dims : 1200 w x 700 d x 850 h (mm)    On castors

### **Halo KURF15-2 Fridge / Freezer Combo RRP \$4700 + GST**

Dual temperature 2 Door Undercounter

Freezer Capacity 177 Litre    Temp Range -21c to -12c,    Gas : 404a

Fridge capacity 189 Litre    Temp Range 1c to 5c    Gas : 134a

2 doors, 1 shelf per door, 3 Amps, input power 316 w, Weight 96kg

Dims : 1500 w x 700 d x 850 h (mm)    On castors



### **Halo KURF18-3 Fridge / Freezer Combo RRP \$4900 + GST**

Dual temperature 3 Door Undercounter

Freezer Capacity 151 Litre    Temp Range -21c to -12c,    Gas : 404a

Fridge capacity 314 Litre    Temp Range 1c to 5c    Gas : 134a

3 doors, 1 shelf per door, 4.4 Amps, input power 366 w, Weight 112kg

Dims : 1800 w x 700 d x 850 h (mm)    On castors

Contact Halo Refrigeration

Phone : 1300 ORFORD (673 673)

Web : [www.halorefrigeration.com.au](http://www.halorefrigeration.com.au)

Sales@orford.com.au







# halo®



## HALO FOOD SERVICE K Series UNDERBENCH RANGE

### Halo KGR9-1 Glass Door Refrigerator RRP \$3245 + GST



1 Door Undercounter Refrigerator Digital display and control  
Capacity 137Litre Temp Range 1c to 5c Gas : 134a  
1 door with LOW E glass, 1 shelf, Weight 80kg  
Dims : 900 w x 700 d x 850 h (mm) On castors

### Halo KGR12-2 Glass Door Refrigerator RRP \$3850 + GST

2 Door Undercounter Refrigerator Digital display and control  
Capacity 311 Litre Temp Range 1c to 5c Gas : 134a  
2 doors with LOW E glass, 2 shelf, Weight 96kg  
Dims : 1200 w x 700 d x 850 h (mm) On castors



### Halo KGR15-2 Glass Door Refrigerator RRP \$4320 + GST



2 Door Undercounter Refrigerator Digital display and control  
Capacity 425 Litre Temp Range 1c to 5c Gas : 134a  
2 doors with LOW E glass, 2 shelf, Weight 96kg  
Dims : 1500 w x 700 d x 850 h (mm) On castors

### Halo KGR18—3 Glass Door Refrigerator RRP \$4975 + GST

3 Door Undercounter Refrigerator Digital display and control  
Capacity 538 Litre Temp Range 1c to 5c Gas : 134a  
3 doors with LOW E glass, 3 shelf, Weight 127kg  
Dims : 1800 w x 700 d x 850 h (mm) On castors



## Contact Halo Refrigeration

Phone : 1300 ORFORD (673 673)

Web : [www.halorefrigeration.com.au](http://www.halorefrigeration.com.au)

Sales@orford.com.au





# halo®



## HALO BACK BAR FRIDGES—900 high



### **Halo TB6-1G Glass Door Back Bar Fridge RRP \$2895 + GST**

1 Door Back Bar Refrigerator with LOW E glass

Capacity 125 Litres

Refrigerant : R134a

Weight 60 kg

Temperature range 1c to 8 c

Dims : 600 w x 515 d x 900 h

### **Halo TB9-2G Glass Door Back Bar Fridge RRP \$3650 + GST**

2 Door Back Bar Refrigerator with LOW E glass

Capacity 190 Litres

Refrigerant : R134a

Weight 60 kg

Temperature range 1c to 8 c

Dims : 900 w x 515 d x 900 h



### **Halo TB913-3G Glass Door Back Bar Fridge RRP \$3850 + GST**

3 Door Back Bar Refrigerator with LOW E glass

Capacity 300 Litres

Refrigerant : R134

Weight 60 kg

Temperature range 1c to 8 c

Dims : 1352 w x 515 d x 900 h



Contact Halo Refrigeration

Phone : 1300 ORFORD (673 673)

Web : [www.halorefrigeration.com.au](http://www.halorefrigeration.com.au)

Sales@orford.com.au





# halo®



## HALO BACK BAR FRIDGES—800mm high



### **Halo TB6-1G Glass Door Back Bar Fridge RRP \$2795 + GST**

1 Door Back Bar Refrigerator with LOW E glass

Capacity 110 Litres

Refrigerant : R134a

Weight 55 kg

Temperature range 1c to 8 c

Dims : 600 w x 515 d x 800 h

Height includes 10mm stub feet levellers

### **Halo TB9-2G(800) Glass Door Back Bar Fridge RRP \$3650 + GST**

2 Door Back Bar Refrigerator with LOW E glass

Capacity 165 Litres

Refrigerant : R134a

Height includes 10mm stub feet levellers

Weight 70 kg

Temperature range 1c to 8 c

Dims : 900 w x 515 d x 800 h



### **Halo TB913-3G(800) Glass Door Back Bar RRP \$3950 + GST**

3 Door Back Bar Refrigerator with LOW E glass

Capacity 261 Litres

Refrigerant : R134

Weight 95 kg

Height includes 10mm stub feet levellers

Temperature range 1c to 8 c

Dims : 1352 w x 515 d x 800 h



Contact Halo Refrigeration

Phone : 1300 ORFORD (673 673)

Web : [www.halorefrigeration.com.au](http://www.halorefrigeration.com.au)

Sales@orford.com.au





# halo®



## HALO FOOD SERVICE SALAD AND SANDWICH TABLES



### **Halo TOG AMST-24 Mega Top Salad Table RRP \$4950 + GST**

Mega top salad / sandwich table 24 pans

Stainless steel 863mm deep salad table

Insulated hood with 24 pans cutting board

Digital temp display temp range 1c to 5c

2 adjustable shelves Refrigerant : R134a 4.7 Amps 366w

Dims : 1530 w x 863 d x 992 h On lockable castors 141mm high

Weight 160kg

### **Halo TOG AMST-30 Mega Top Salad Table RRP \$6150 + GST**

Mega top salad / sandwich table 30 pans

Stainless steel 3 door 863mm deep salad table

3 shelves, 30 pans, 2 hoods cutting board

Capacity 640 litre temp range 1c to 5c

3 adjustable shelves Refrigerant : 134a 5.8 Amps Power 440w

Dims : 1846 w x 863 d x 992 h On lockable castors 141 mm high

Weight 180kg



Contact Halo Refrigeration

Phone : 1300 ORFORD (673 673)

Web : [www.halorefrigeration.com.au](http://www.halorefrigeration.com.au)

Sales@orford.com.au





# halo®



## HALO FOOD SERVICE K Series SALAD AND SANDWICH TABLES



### Halo KHR9-1

### Salad Table

**RRP \$3350 + GST**

Salad Side prep Table with hood  
Capacity 213 Litres  
Digital control

Dims : 900 w x 700 d x 978 h mm (1134 inc castors)  
1 door 1 shelf  
Amps 2.5, 314 w Power

Refrigerant : R134a

Weight 75 kg

### Halo KHR12-2

### Salad Table

**RRP \$4350 + GST**

Salad Side prep Table w hood  
Capacity 309 Litres  
Digital control

Dims : 1200 w x 700 d x 978 h mm (1134 inc castors)  
2 door 2 shelves  
Amps 3, 314 w Power

Refrigerant : R134a

Weight 89 kg



### Halo KHR15-2

### Salad Table

**RRP \$4800 + GST**

Salad Side prep Table with hood  
Capacity 420 Litres  
Digital control

Dims : 1500 w x 700 d x 978 h mm (1134 inc castors)  
2 door 2 shelves  
Amps 3, 314 w Power

Refrigerant : R134a

Weight 100 kg

### Halo KHR18-3

### Salad Table

**RRP \$6200 + GST**

Salad Side prep Table with hood

Dims : 1800 w x 700 d x 978 h mm (1134 inc castors)

3 door 3 shelves

Amps 4.4, 366 w Power

Refrigerant : R134a

Weight 120 kg

Capacity 516 Litres

Digital control



## Contact Halo Refrigeration

Phone : 1300 ORFORD (673 673)

Web : [www.halorefrigeration.com.au](http://www.halorefrigeration.com.au)

Sales@orford.com.au





# halo®



## HALO FOOD SERVICE OPEN DELI CASES

### **Halo MNY937 Open Deli Refrigerator RRP \$6800 + GST**

Multi Deck Self contained refrigerator

ASPERA compressor

LED Lights

4 adjustable shelves plus Base night blind as standard

Refrigerant R404a

Temperature range 3—5 c at 25 degrees ambient

Low front 450 mm

Toughened Glass end walls for maximum display

Heavy duty castors

Digital temperature display

Dimensions : 937 w (1002 inc end walls) x 700 d (overhead canopy 800w) x 2000 h

Position cabinet a minimum of 100mm off walls to allow air flow

10 Amps



### **Halo MNY1250 Open Deli Refrigerator RRP \$8400 + GST**

Multi Deck Self contained refrigerator

ASPERA compressor

LED Lights

4 adjustable shelves plus Base night blind as standard

Refrigerant R404a

Temperature range 3—5 c at 25 degrees ambient

Low front 450 mm

Toughened Glass end walls for maximum display

Heavy duty castors

Digital temperature display

Dimensions : 1250 w (1315 inc end walls) x 700 d (overhead canopy 800w) x 2000 h

Position cabinet a minimum of 100mm off walls to allow air flow

10 Amps



Contact Halo Refrigeration

Phone : 1300 ORFORD (673 673)

Web : [www.halorefrigeration.com.au](http://www.halorefrigeration.com.au)

Sales@orford.com.au





# halo®



## HALO FOOD SERVICE OPEN DELI CASES

### **Halo MNY 1875 Open Deli Refrigerator RRP \$10 450 + GST**

Multi Deck Self contained refrigerator 1342 Litres  
ASPERA compressor LED Lights  
4 adjustable shelves plus Base night blind as standard  
Refrigerant R404a  
Temperature range 3—5 c at 25 degrees ambient  
Low front 450 mm  
Toughened Glass end walls for maximum display  
Heavy duty castors Digital temperature display  
Dimensions : 1875 w (1940 inc end walls ) x 700 d (overhead canopy 800) x 2000 h  
Position cabinet 100mm off walls to allow air flow  
Power consumption (Kwh/24h) 35 15 Amps



### **Halo MNY2500 Open Deli Refrigerator RRP \$12450 + GST**

Multi Deck Self contained refrigerator  
ASPERA compressor LED Lights  
4 adjustable shelves plus Base night blind as standard  
Refrigerant R404a  
Temperature range 3—5 c at 25 degrees ambient Low front 450 mm  
Toughened Glass end walls for maximum display  
Heavy duty castors Digital temperature display  
Dimensions : 2500 w (2565 w inc end walls) x 700 d (overhead canopy 800) x 2000 h  
Position cabinet 100 mm off walls to allow for air flow  
Power consumption (Kwh/24h) 44 15 Amps Cabinet weight : 505kg



Contact Halo Refrigeration

Phone : 1300 ORFORD (673 673)

Web : [www.halorefrigeration.com.au](http://www.halorefrigeration.com.au)

Sales@orford.com.au





# halo®



## HALO FOOD SERVICE DELI CASES with DOOR

### **Halo MNYD 2500 Refrigerator RRP \$14,050 + GST**

Multi Deck Self contained refrigerator with doors

ASPERA compressor

LED Lights

4 adjustable shelves plus Base night blind as standard

Refrigerant R404a

Temperature range 3—5 c at 25 degrees ambient Low front 450 mm

Toughened Glass end walls for maximum display

Heavy duty castors

Digital temperature display

Dimensions : 2500 w (2565 w inc end walls) x 725d (overhead canopy 800) x 2000 h

Position cabinet 100 mm off walls to allow for air flow

Power consumption (15.6kwh/24h)

15 Amps

Cabinet weight : 505kg



Contact Halo Refrigeration

Phone : 1300 ORFORD (673 673)

Web : [www.halorefrigeration.com.au](http://www.halorefrigeration.com.au)

Sales@orford.com.au







## HALO FOOD SERVICE RANGE



Value add to your fridge

Add an opaque front to your glass door fridge for a Euro look

\$120 + GST per fridge door



Contact Halo Refrigeration

Phone : 1300 ORFORD (673 673)

Web : [www.halorefrigeration.com.au](http://www.halorefrigeration.com.au)

[Sales@orford.com.au](mailto:Sales@orford.com.au)





# *CyberChill* REFRIGERATION



- **Wall Cabinets**  
Stainless steel interior & exterior
- High ambient (43°C) refrigeration system
- Zero ODP injected polyurethane insulation
- i'Cool energy saving controller with alarms
- Gastronorm GN 1/1 shelving system
- Easy to clean coved interior and base
- Self closing doors
- Removable magnetic door gasket
- Heavy duty brake and swivel castors
- Removable racking system with anti-tilt slides
- Waste heat vaporiser
- Wall mounting kit
- Left hand condensing units



Contact Halo Refrigeration

Phone : 1300 ORFORD (673 673)

Web : [www.halorefrigeration.com.au](http://www.halorefrigeration.com.au)

[Sales@orford.com.au](mailto:Sales@orford.com.au)





# **CyberChill**

## REFRIGERATION

### CyberChill Cold & Freezer Rooms

- 40°C ambient refrigeration system
- Modular insulated panels - any size room
- 75 / 100mm, high density polyurethane panels & floor
- Zero ODP injected polyurethane insulation
- White colorbond finish - interior / exterior
- Durable chequer-plate flooring
- Unique tongue & groove, cam-lock construction
- Soft rubber gasket between all joints - no need for silicon
- Simple, quick assembly / disassembly
- Wide 180°, recessed hinged door opening - 900mm x 1900mm (h)
- Internal, luminous, door safety release
- Kason latch (lockable) & strike, Kason self-raising hinges
- Hydraulic door closer, ensuring air-tight seal
- Heated door-frame & pressure relief valve
- Light switch with indicator on/off lamp



Contact Halo Refrigeration

Phone : 1300 ORFORD (673 673)

Web : [www.halorefrigeration.com.au](http://www.halorefrigeration.com.au)

Sales@orford.com.au





## Medical Fridges by Halo



### Halo HB80G2 80 Litre

Dimensions : 500w x 560d x 830h (mm)

Free standing single door cabinet

Power Consumption : 3.08Kwh / 24 Hrs

Fully Approved - SAA Electrical - EMC (C-Tick) - QCPP Approved (Quality Care Pharmacy Program)

White with Silver Doors

4 adjustable feet 2 shelves

Weight : 66kg

Purpose built QCPP accredited vaccine refrigerator with complete electronic monitoring system maintaining same temperature on each shelf.

Easy to use data logger to download temperature history with ease.

- Data logger includes visual alert, records minimum and maximum temperatures and power failure alarm.
- ABS and double glazed door.
- 1°C>4°C in ambient 32°C.
- 240V 50Hz , 250Watt.
- Forced air ventilation, excellent chilling.
- Internal light.
- Sound Level DBA 55.
- Lock fitted.
- Complete 100% reliability guaranteed.
- Australian Commercial **MEPS** Approved.
- Also International ISO9001, 14001 + OHSAS 18001 Certified.



Contact Halo Refrigeration

Phone : 1300 673 673

Web : [www.halorefrigeration.com.au](http://www.halorefrigeration.com.au)

Sales@[halorefrigeration.com.au](mailto:halorefrigeration.com.au)





## Medical Fridges by Halo

### Halo VF371G2

Dimensions : 595w x 595d x 1930h (mm)

Capacity : 381 Litres

Door opened width : 1180mm

Power Consumption : 4.17 Kwh / 24 Hrs

Fully Approved - MEPS - SAA Electrical - EMC (C-Tick) - QCPP Approved (Quality Care Pharmacy Program)

White with Silver Doors

4 adjustable feet

5 x full sized shelves plus 1 x 1/2 sized industrial shelf

Weight : 93kg



Purpose built QCPP accredited vaccine refrigerator with complete electronic monitoring system maintaining same temperature on each shelf.

- W: 595mm x D: 595mm x H: 1930mm.
- 10mm feet.
- Allow 10mm for door swing, unit is 1180mm with open door.
- Depth is 640mm including handle.
- Easy to use data logger to download temperature history with ease.
- Data Logger includes visual alert, records minimum and maximum temperatures and power failure alarm.
- ABS and double glazed door.
- 2°C>8°C in ambient 32°C.
- 240V 50Hz , 250Watt.
- Silver door frame and white body.
- Forced air ventilation, excellent chilling.
- Internal light.
- 4.17Kwh / 24Hr.
- Reversible door available on request, lock fitted.
- Noise Level: DBA 55.
- Lock fitted.
- Fits 476 x cans.
- Complete 100% reliability guaranteed
- Also International ISO9001, 14001 + OHSAS 18001 Certified



Contact Halo Refrigeration

Phone : 1300 673 673

Web : [www.halorefrigeration.com.au](http://www.halorefrigeration.com.au)

Sales@[halorefrigeration.com.au](mailto:halorefrigeration.com.au)





## Medical Fridges by Halo



### Halo VF311G2

Dimensions : 595w x 595d x 1630h (mm)

Capacity : 306 Litres

Door opened width : 1180mm

Power Consumption : 3.69 Kwh / 24 Hrs

Fully Approved - MEPS - SAA Electrical - EMC (C-Tick) - QCPP Approved (Quality Care Pharmacy Program)

White with Silver Doors

4 adjustable feet

4 x full sized shelves plus 1 x 1/2 sized industrial shelf

Weight : 74kg

Purpose built QCPP accredited vaccine refrigerator with complete electronic monitoring system maintaining same temperature on each shelf.

Depth is 640mm including handle.

- Easy to use data logger to download temperature history with ease.
- Data logger includes visual alert, records minimum and maximum temperatures and power failure alarm.
- ABS and double glazed door.
- 2°C>8°C in ambient 32°C.
- Silver door frame and white body.
- Forced air ventilation, excellent chilling.
- Internal light.
- Energy efficient, 3.69Kwh / 24Hr.
- Stylish look.
- Reversible door available on request, lock included.
- Noise level DBA 55.
- Complete 100% reliability guaranteed.
- Australian Commercial **MEPS** Approved.
- Also International ISO9001, 14001 + OHSAS 18001 Certified



Contact Halo Refrigeration

Phone : 1300 673 673

Web : [www.halorefrigeration.com.au](http://www.halorefrigeration.com.au)

Sales@[halorefrigeration.com.au](mailto:halorefrigeration.com.au)





## Halo10—Hotel Milk Dispenser

**\$980+ GST**

### Halo 10—*Hotel Milk dispenser*

The Halo 10 is a chilled Milk dispenser Ideal for storing, chilling and dispensing milk and is built to withstand the demands of high traffic areas such as Hotels, Resorts, Clubs, Pubs, Cafeterias, etc.

Operates at +2 degrees to + 8 degrees at 35 degrees ambient temp and 60% humidity



Halo 10	Refrigerated Milk Dispenser
Specifications	
Construction	Full Stainless Steel Interior / Exterior
Capacity	2 x 5 Litre Milk Bladders
Dimensions	386 W x 452 D x 810 H
Ext Dimensions	330W x 270 D x 420 H
Weight	35Kg
Operating Temp	+2° - +8° C.
Ambient Temperature	0—30° C.
Power Point	220 - 240v 50Hz. (Standard GPO)
Thermometer	Carel Temperature Display
Doors	1 x Solid Stainless Steel with outer illuminated LED sign box
Footing	Flat Base

Contact Halo Refrigeration

Phone : 1300 ORFORD (673 673)

Web : [www.halorefrigeration.com.au](http://www.halorefrigeration.com.au)

Sales@orford.com.au





# halo®



## Manitowoc Ice Machines



### Manitowoc Sotto UG30

Production 31kg / 24 hrs @ 21c Air  
Production 25kg / 24 hrs @ 32c Air  
Ice Storage 10kg  
450w x 475d x 650h (ex legs)      Ice type - Octagon  
Bin integral      Optional set of 4 legs for \$70 + GST

### Manitowoc Sotto UG50

Production 57kg / 24 hrs @ 21 c Air  
Production 43kg / 24 hrs @ 32 c Air  
Ice storage 25kg  
550w x 550d x 800h (ex legs)      Ice type - Octagon  
Bin Integral      Optional set of 4 legs for \$70 + GST



### Manitowoc Sotto UG65

Production 65kg / 24hrs @ 21c Air  
Production 58kg / 24hrs @ 32c Air  
Ice Storage 44kg  
700w x 600d x 900h (mm) excludes legs  
Ice type - Octagon    Bin Integral      Optional set of 4 legs for \$70 + GST

### Manitowoc Sotto UG80

Production 85kg / 24hrs @ 21c Air  
Production 67kg / 24hrs @ 32c Air  
Ice storage 44kg  
700 w x 600d x 900h (mm) excludes legs  
Ice type - Octagon      Bin integral      Optional set of 4 legs for \$70 + GST



Contact Halo Refrigeration

Phone : 1300 673 673

Web : [www.halorefrigeration.com.au](http://www.halorefrigeration.com.au)

Sales@halorefrigeration.com.au







View our other catalogues

[www.orford.com.au](http://www.orford.com.au)



Contact Halo Refrigeration

Phone : 1300 673 673

Web : [www.halorefrigeration.com.au](http://www.halorefrigeration.com.au)

[Sales@halorefrigeration.com.au](mailto:Sales@halorefrigeration.com.au)





# halo®



[www.halorefrigeration.com.au](http://www.halorefrigeration.com.au)

## Refrigeration Solutions

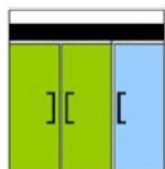

Contact Halo Refrigeration

Phone : 1300 673 673

Web : [www.halorefrigeration.com.au](http://www.halorefrigeration.com.au)

Sales@halorefrigeration.com.au





**Head Office**

**Unit 5, Quantum Business Park**

**1 Gardner Crt**

**Wilsonton Qld 4350**

**Postal Address**

**PO Box 18120**

**Clifford Gardens**

**Qld 4350**

**ABN : 72 150865008**

National Number :

**1300 ORFORD (1300 673 673)**

National Spare Parts :

0448 ORFORD (0448 673 673)

National Sales :

Jeff Ash : 0400 013 958

Email : [Jeffash@orford.com.au](mailto:Jeffash@orford.com.au)

[www.orford.com.au](http://www.orford.com.au)

Sales Enquiries :

Email : [sales@orford.com.au](mailto:sales@orford.com.au)

Phone : 1300 ORFORD (1300 673 673)

Our websites :

[www.orford.com.au](http://www.orford.com.au)

[www.flowerfridges4u.com.au](http://www.flowerfridges4u.com.au)

[www.halorefrigeration.com.au](http://www.halorefrigeration.com.au)

[www.orforddigital.com.au](http://www.orforddigital.com.au)

[www.chocolatefridges4u.com.au](http://www.chocolatefridges4u.com.au)

[www.icemachines4u.com.au](http://www.icemachines4u.com.au)

